

## BASAMAK PROFİLLERİ

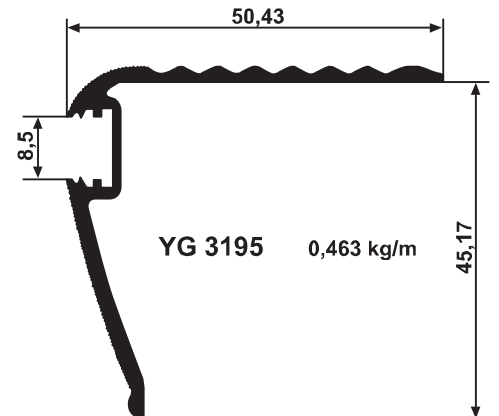

## BASAMAK PROFİLLERİ

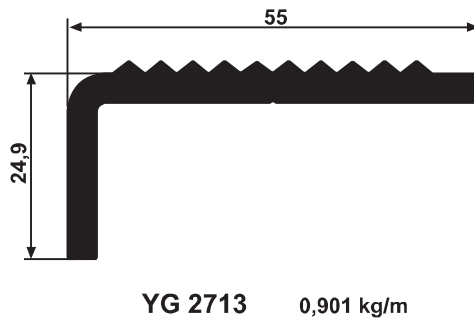
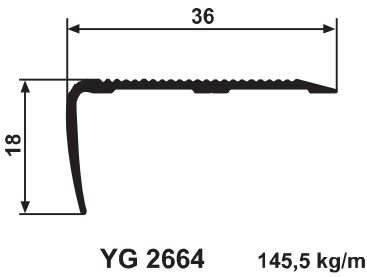
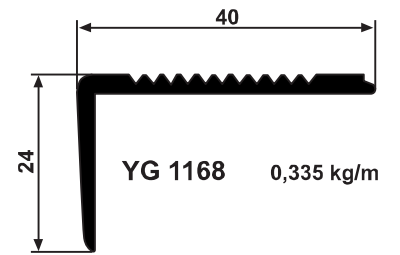
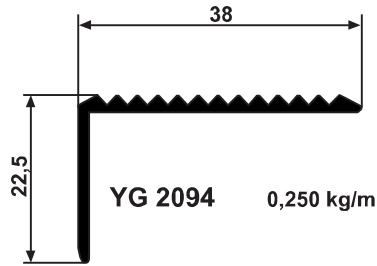
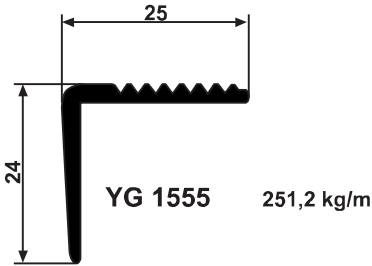
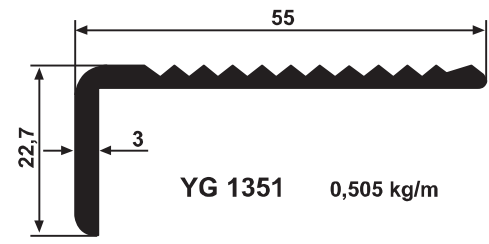
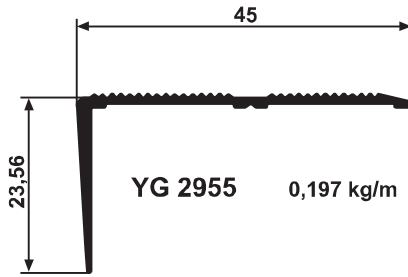
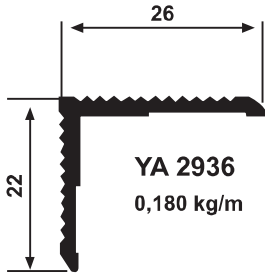
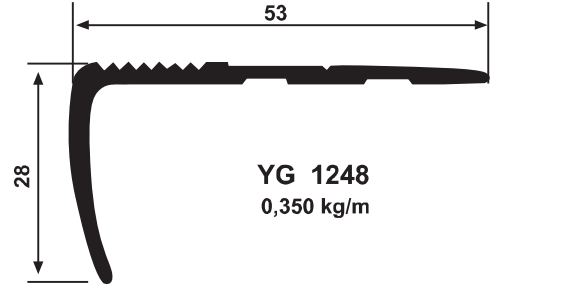
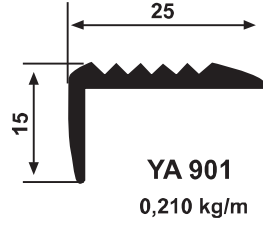
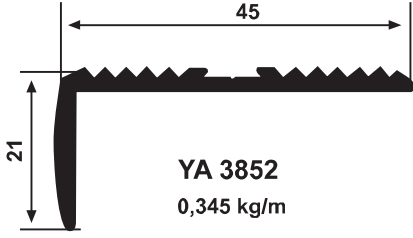
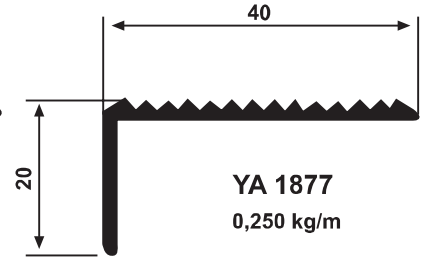
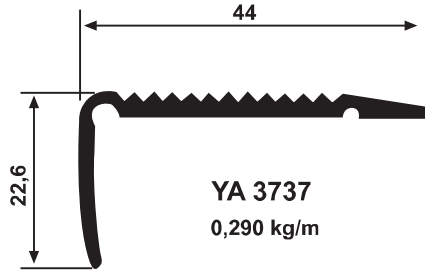
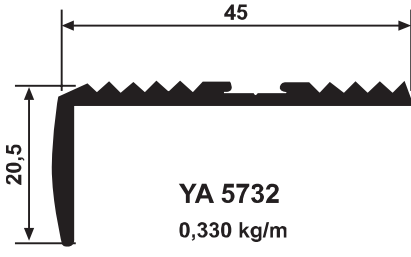
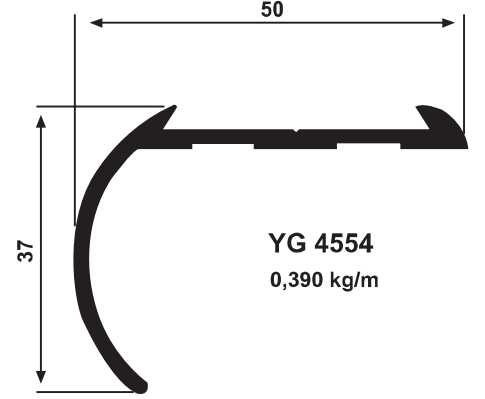
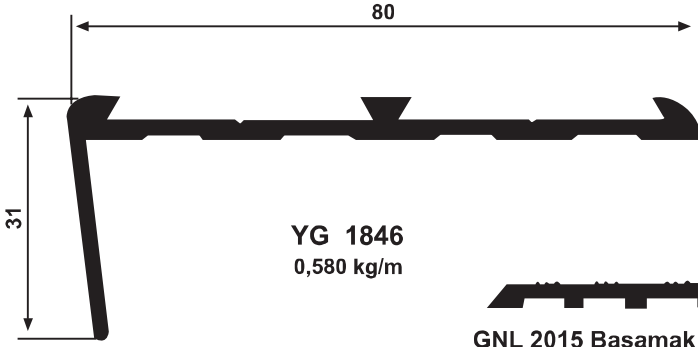

**GNL 2015 Basamak Fıtlı**  
YG 1846, YG 4554 ve YG 4703 ile kullanılır.  
5 kg / 30 m (M 197)

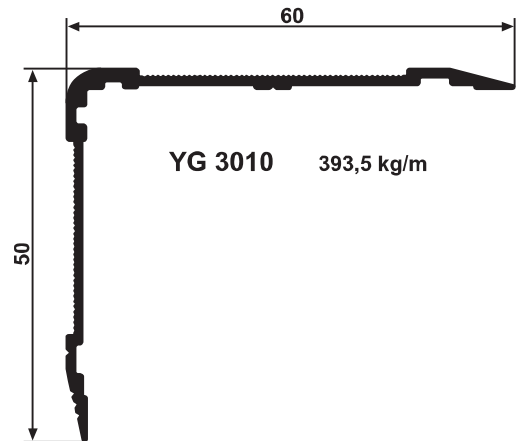
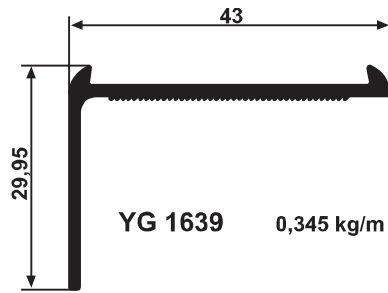
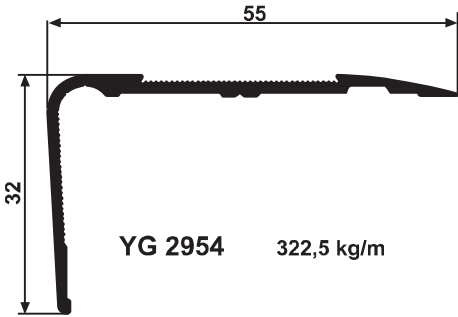
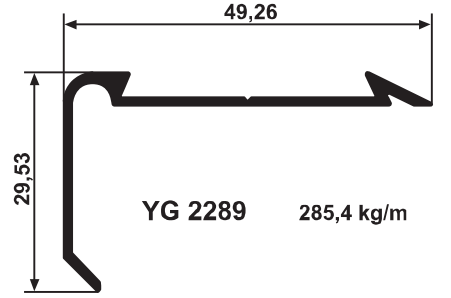
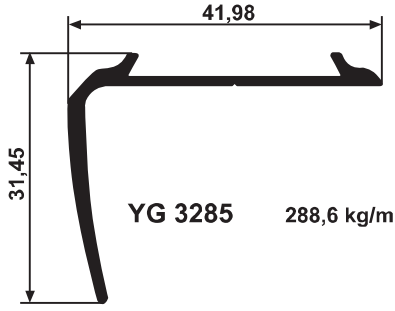
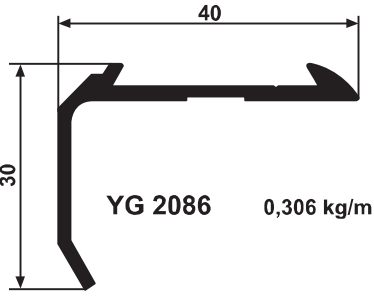
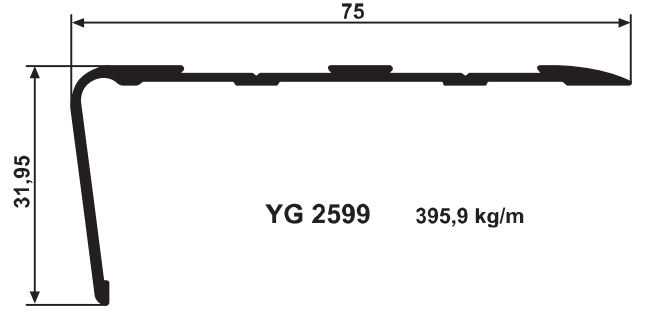
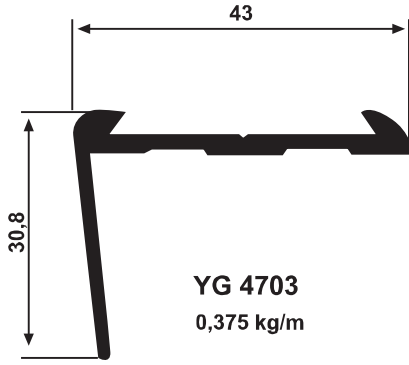

# BASAMAK PROFİLLERİ

